

Navodila za uporabo

Priporočljivo je, da ob nakupu razpakiranega izdelka v trgovini preverite njegovo kakovost in popolnost. Izdelek je treba sestaviti tako, kot je opisano v tem priročniku.

Medtem ko je izdelek v uporabi, je treba občasno zategniti ohlapne vijačne spoje.

Če je treba premikati predmete, po stanovanju, morate pred premikanjem izdelek popolnoma sprostiti z bremena (ležišča). Da bi preprečili poškodbe obstoječih nosilcev, je treba izdelek pred premikanjem dvigniti. Pohištvo ne sme biti izpostavljeno stiku z vodo.

Brisanje prahu na izdelku je treba opraviti z rahlo vlažno mehko krpo.

Da bi preprečili deformacijo delov in spremembo barve izdelkov, pohištva ne nameščajte na neposredno sončno svetlobo.

Medtem ko je izdelek v uporabi, je PREPOVEDANO:

- nameščati pohištvo v bližini grelnih naprav, blizu surovih sten in v prostorih z relativno vlažnostjo več kot 70 %;
- segrevati elementov pohištva na temperaturo, višjo od 40 C;
- med sestavljanjem in uporabo kompleta izdelkov stopati na vodoravne ščite in okna;
- uporabljati kemičnih čistil za čiščenje pohištva.

Garancija proizvajalca







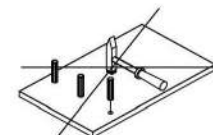
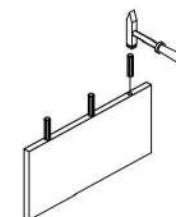
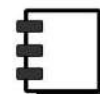
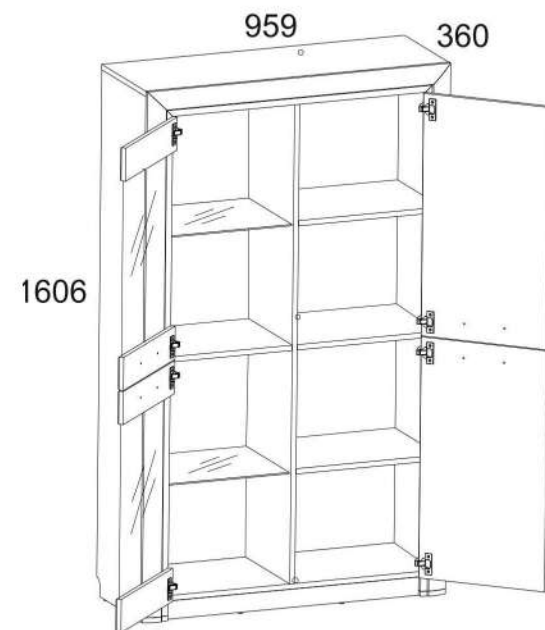











1. Garancijski rok za uporabo izdelka - 24 mesecev od datuma prodaje. V garancijskem roku proizvajalec zagotavlja popravilo ali zamenjavo izdelkov, če uporabnik ni kršil pravil uporabe.
2. Reklamacije mora potrošnik vložiti neposredno pri trgovski organizaciji, v kateri je bilo pohištvo kupljeno, pri čemer mora predložiti "Navodila za uporabo" in kopijo potrdila o prodaji.
3. Izdelek, ki je del kompleta, izpolnjuje zahteve državni standardi 16371-93, TR TS 025/2012.
4. Življenjska doba pohištva - 10 let.
5. Proizvajalec si pridržuje pravico do sprememb v zasnovi izdelka, ne da bi pri tem ogrozil njegove zahteve glede zasnove in uporabe.
6. Za sestavljanje izdelkov je priporočljivo vključiti usposobljeno osebje.

To je pomembno! Navodila shranite za primer ponovne montaže pohištva ali reklamacije. Pri uveljavljanju reklamacije uporabite zapis iz navodila.

OTILIA 1D1W-100



N _o	DOLŽINA MM.	ŠIRINA MM.	GLOBINA MM.		PAKET
1	958	335	16	1	1/5
2	924	335	16	1	1/5
3	454	335	16	1	1/5
4	454	335	16	1	1/5
5	452	325	6	2	1/5
6	452	335	16	2	1/5
7	1585	335	16	1	2/5
8	1585	335	16	1	2/5
9	1514	335	16	1	2/5
10	924	55	16	2	1/5
11	730	396	18	1	3/5
12	730	396	18	1	3/5
13	396	730	18	2	3/5
15;16	1587	80	25	2	4/5
17	959	80	25	1	4/5
18	1540	475	2,5	2	5/5

A1  28	A2  32	G  1,5x26 40
C1  6x35 43	A9  2	R5  3x30 4
E2  8	D1  8	R24  7x50 2
V5  2	R23  6,3x13 16	Ri2  3,5x16 16
S3  5	R3  3x20 5	S5  16
H19  4	P4  8	P1  8
B5  1	S6  1	M12  M4x25 8
N1  6	I  1	Q  4

I

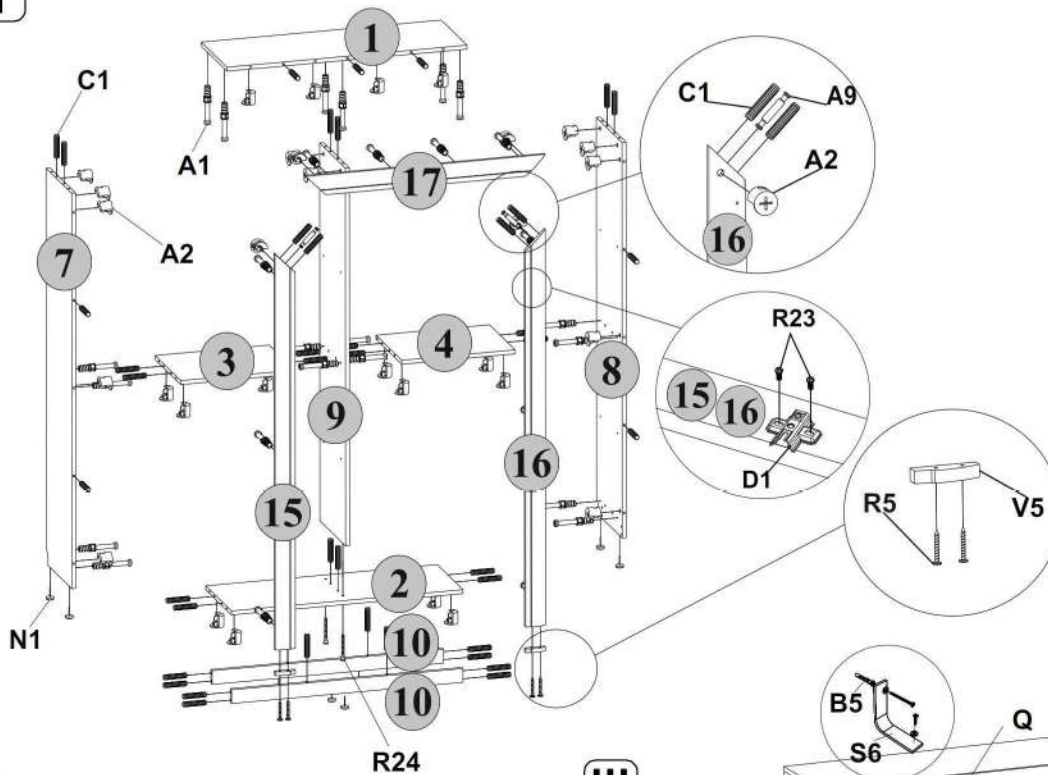

II

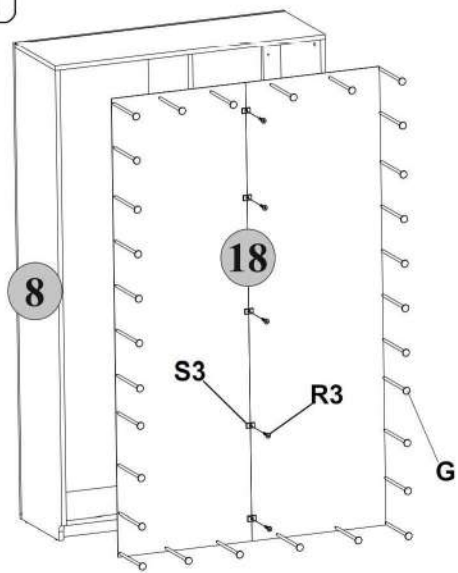

III

